



# Panasonic<sup>®</sup>

## **Quick Reference Guide** Digital Proprietary Telephone





Model No. **KX-DT321C**

Thank you for purchasing a Digital Proprietary Telephone (DPT). Please read this manual carefully before using this product and save this manual for future use.

For more details, please refer to the manuals of the PBX.

**Note:** In this manual, the suffix of each model number is omitted unless necessary.

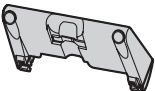
### **Accessories (included)**

<input type="checkbox"/> Handset: 1 	<input type="checkbox"/> Handset Cord: 1 	<input type="checkbox"/> Stand: 1 
<input type="checkbox"/> Screws for wall: 2 	<input type="checkbox"/> Telephone Line Cord: 1 	

## Location of Controls

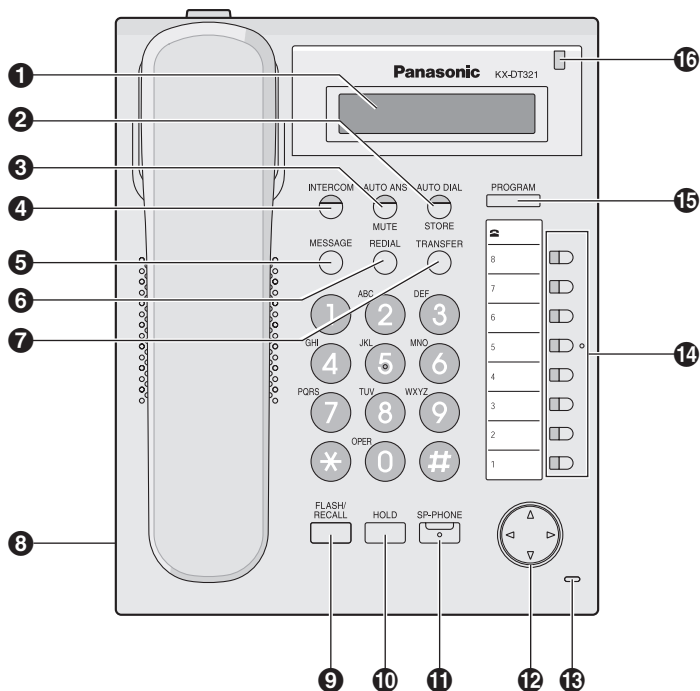

## *Location of Controls*



---

- 1 LCD (Liquid Crystal Display)**
- 2 AUTO DIAL/STORE:** Used for System/Personal Speed Dialling or storing programme changes.
- 3 AUTO ANS (Auto Answer)/ MUTE:** Used to receive an incoming call in hands-free mode or mute the microphone/handset during a conversation.
- 4 INTERCOM:** Used to make or receive intercom calls.
- 5 MESSAGE:** Used to leave a message waiting indication or call back the party who left the message waiting indication.
- 6 REDIAL:** Used to redial the last dialled number.
- 7 TRANSFER:** Used to transfer a call to another party.
- 8 Headset Jack**
- 9 FLASH/RECALL:** Used to disconnect the current call and make another call without hanging up.
- 10 HOLD:** Used to place a call on hold.
- 11 SP-PHONE (Speakerphone):** Used for performing hands-free operations.
- 12 Navigator Key:** Used to adjust the volume and the display contrast or select desired items.
- 13 Microphone:** Used for hands-free conversations.
- 14 Flexible Buttons:** Used to seize an outside line or perform a feature that has been assigned to the key.
- 15 PROGRAM:** Used to enter and exit the personal programming mode.
- 16 Message/Ringer Lamp:** When you receive a call, the lamp flashes red. When someone has left you a message, the lamp stays on red.

# Settings

<b>Speaker volume</b>	<i>While in a hands-free conversation</i>	 <p>Press <b>Up</b> to increase or <b>Down</b> to decrease the volume.</p>
<b>Handset/Headset volume<sup>*1</sup></b>	<i>While using the handset or headset</i>	
<b>Ringer volume</b>	<i>While on-hook or receiving a call</i>	

**LCD Contrast**  
*While on-hook*

PROGRAM  ► (0) (1) ► AUTO DIAL  STORE ►  ► AUTO DIAL  STORE ► PROGRAM

**Ring Tone**







PROGRAM  ►  $\left( \begin{array}{c} \text{D} \\ \text{(CO)} \\ \text{OR} \\ \text{INTERCOM} \\ \text{⊖} \end{array} \right)$  ►  $\left( \begin{array}{cc} (0) & (1)^{*2} \\ | & \\ (0) & (8) \end{array} \right)$  ► AUTO DIAL  STORE ► PROGRAM

Press **2 times**.















<sup>\*1</sup> If you hear your own voice through the handset or headset, decrease the volume.

<sup>\*2</sup> The ring tone pattern of patterns 09 to 30 is the same as pattern 01.

## Icon Meanings

 = Flexible button   
  = Off-hook   
  = On-hook  
 = Feature number   
  = Talk   
  = Confirmation Tone

## Making Calls

Calling	
<b>To an extension</b>  ► <span style="border: 1px solid black; padding: 2px;">extension no.</span> ► 	<b>To an outside party</b>  ►  (CO) ► <span style="border: 1px solid black; padding: 2px;">outside phone no.</span> ► 
Redial	
 ► REDIAL ►  ► 	
Quick Dialling	
 ► <span style="border: 1px solid black; padding: 2px;">quick dial no.</span> ► 	
One-touch Dialling	
<b>To store</b> PROGRAM <span style="border: 1px solid black; padding: 2px;">  </span> ►  (CO) ► <span style="border: 1px solid black; border-radius: 50%; padding: 2px;">2</span> ► <span style="border: 1px solid black; padding: 2px;">desired no.* (max. 32 digits)</span> ► AUTO DIAL <div style="text-align: center;"></div> STORE ► PROGRAM <span style="border: 1px solid black; padding: 2px;">  </span>	
* Enter outside line access number before outside phone number.	
<b>To dial</b>  ►  (One-touch Dialling) assigned as a One-touch Dialling button ► 	

# Features List

## Personal Speed Dialling

### To store

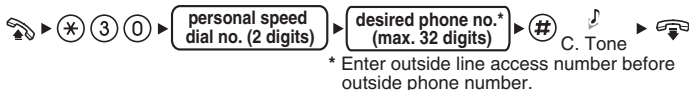

### To dial



## System Speed Dialling

### To dial

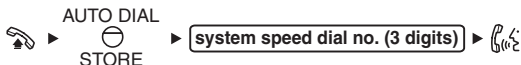

## Doorphone Call



## During a Conversation

### Call Hold

#### To hold



#### To retrieve a call at the holding extension



#### To retrieve an outside call from another extension



### Call Transfer

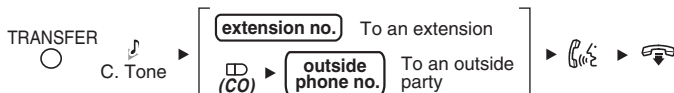

## Useful Features

### Multiple Party Conversation

**To add other parties during a conversation (i.e., conference)**

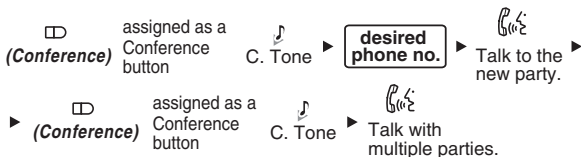

**To leave a conference**

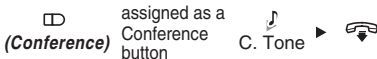

## Setting the Telephone According to Your Needs

### Do Not Disturb

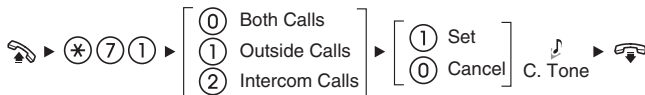

### Timed Reminder

**To set**

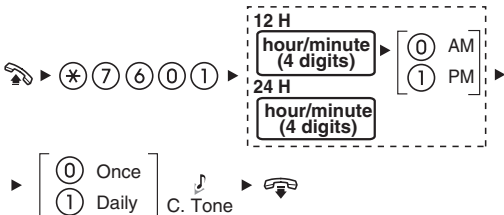

**To cancel**



**To stop or answer the ring back**



# Features List

## Before Leaving Your Desk

### Call Forwarding

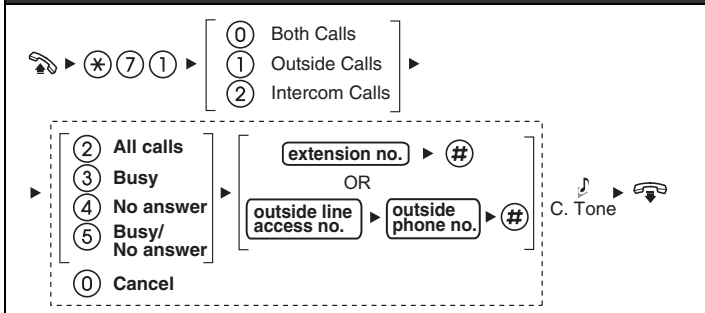

## Making Use of the Voice Mail Service

### Listening to a message

#### From your own extension

☎ ▶ VPS extension no. ▶

▶ Mailbox Password\* #

\* If you have no password, you can skip the last step.

**Note:** VPS = Voice Processing System

#### From someone else's extension

☎ ▶ VPS extension no. ▶

▶ # 6 ▶ \* ▶

▶ mailbox no. ▶

▶ Mailbox Password\* #

\* If you have no password, you can skip the last step.

#### KX-TVM series

- 1 Listen to Message
- 2 Deliver Message
- 3 Mailbox Management
- ▶ 4 Automated Attendant
- 5 Message Notification
- 6 Other Features
- \* End Call

#### KX-TVP series

- 1 Listen to Message
- 2 Deliver Message
- 3 Check Mailbox Distribution
- ▶ 4 Automated Attendant
- 5 Mailbox Management
- 6 Other Features
- \* End Call



## Leaving a message

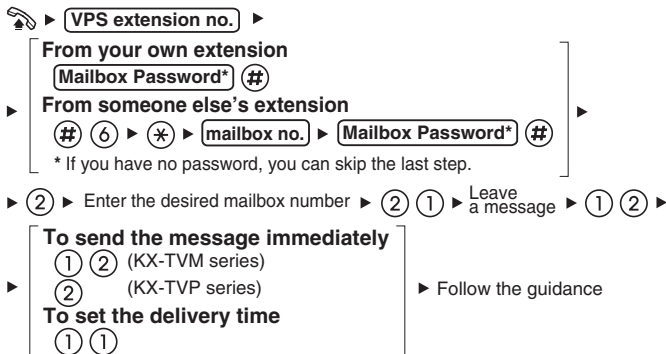

## During playback

- 0** Repeat Voice Guidance
- \*** Exit

- Consult your dealer for more details regarding feature numbers.
- It is possible to assign flexible buttons as feature buttons.
- Control panel/button names and descriptions can be found in "Location of Controls" on page 2.

## Connection

**Note:** In the illustration below, the telephone line cords are routed for wall mounting. When using the stand, refer to "Attaching the Stand" and "Cabling" on page 11 for telephone line cabling.

<Back view>

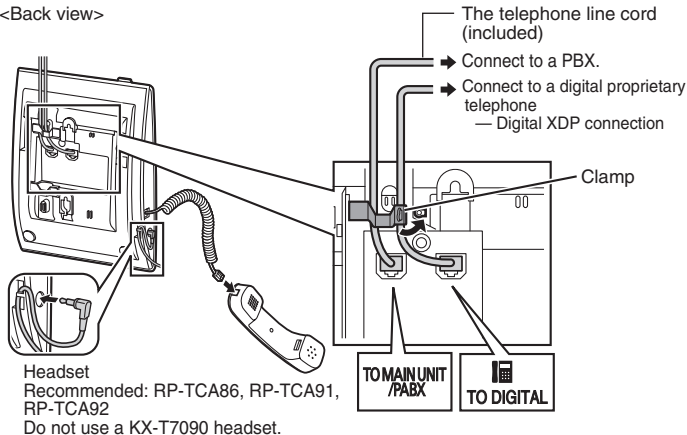

- Consult your dealer for more details about Digital XDP.

### CAUTION:

#### When connecting a headset

- Ensure that the headset cord is wound around the hook to prevent damage to the connector.

#### When connecting cords

- Ensure the cords are inserted in the grooves, and are clamped to prevent damage to the connectors.
- When mounting the unit on the wall, cords may be routed upwards or downwards by using the appropriate cord clamp located on the back of the unit.

### Attaching the Stand

Place the catches (A) of the stand into hooks located in the unit. Gently push the stand in the direction indicated until it locks into place. The stand will be mounted in the high position.

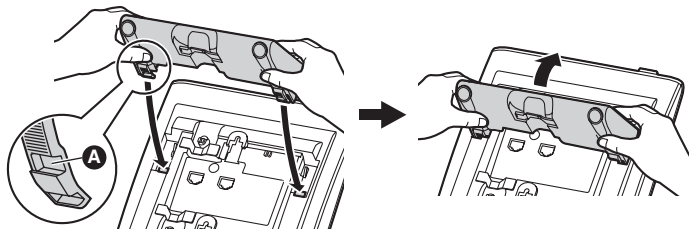

### Removing the Stand

Hold the stand with both hands. Gently rotate the stand in the direction indicated until it is released.

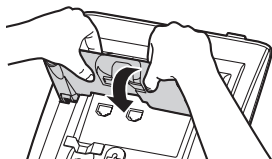

### Cabling

When using the stand, ensure that the cords are clamped as shown.

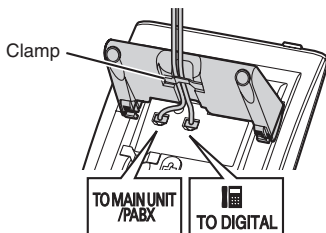

## Stand Usage

---

### Adjusting from High to Low Position

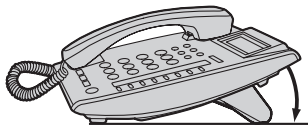

Hold the stand with both hands as shown and rotate the stand in the direction indicated until it locks into the low position (B).

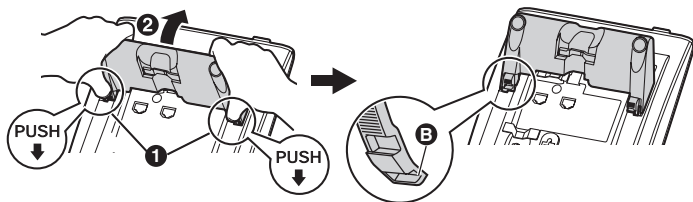

### Adjusting from Low to High Position

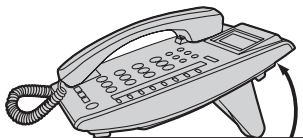

Hold the stand with both hands as shown and rotate the stand in the direction indicated until it locks into the high position (A).

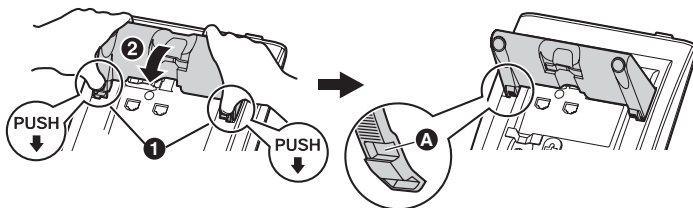

1. Remove the stand if it is attached. For information on removing the stand, refer to page 11.
2. Drive the 2 screws (included) into the wall either 83 mm or 100 mm apart, and mount the unit on the wall.

- You can find a wall mounting template on page 19.
- Make sure that the wall that the unit will be attached to is strong enough to support the unit (approx. 730 g [1.61 lb]).
- Make sure that the telephone line cords are not trapped or pinched against the wall.
- Make sure the cords are securely fastened to the wall.
- When this unit is no longer in use, make sure to detach it from the wall.

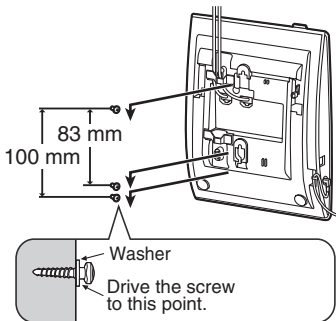

### Locking the Handset Hook

Pull down the handset hook until it locks to prevent the handset from falling off the handset cradle when the unit is mounted to a wall or set at a high angle. To temporarily place the handset down during a conversation, hook it over the top edge of the unit as shown.



## ***Important Information***

---

**When using a KX-DT321 DPT, keep the following conditions in mind.**

- If you are having problems making calls, unplug the extension line and connect a known working telephone. If the known working telephone operates properly, have the defective telephone repaired by an authorised Panasonic factory service centre. If the known working telephone does not operate properly, check the PBX and the internal extension wiring.
- Wipe the unit with a soft cloth. Do not clean the unit with abrasive powders or with chemical agents such as benzene or thinner.
- Use only the correct Panasonic handset.
- Do not disassemble this unit. Dangerous electrical shock could result. The unit must only be disassembled and repaired by qualified service technicians.
- If damage to the unit exposes any internal parts, immediately disconnect the cable or cord.
- Never attempt to insert wires, pins, etc. into the vents or other holes of this unit.

**Take special care to follow the safety suggestions listed below.**

### **Installation**

#### **Environment**

- 1) Do not use this unit near water, for example, near a bathtub, washbowl or sink. Damp basements should also be avoided.
- 2) Keep the unit away from heating appliances and devices that generate electrical noise, such as fluorescent lamps, motors, and televisions. These noise sources can interfere with the performance of the unit. It also should not be placed in rooms where the temperature is less than 5 °C (41 °F) or greater than 40 °C (104 °F).

#### **Placement**

- 1) Do not place heavy objects on top of this unit.
- 2) Care should be taken so that objects do not fall onto, and liquids are not spilled into, the unit. Do not subject this unit to excessive smoke, dust, moisture, mechanical vibration, shock, or direct sunlight.
- 3) Place the unit on a flat surface.

### **WARNING:**

TO PREVENT POSSIBLE FIRE OR ELECTRIC SHOCK, DO NOT EXPOSE THIS UNIT TO RAIN OR MOISTURE.

THIS HANDSET EARPIECE IS MAGNETISED AND MAY RETAIN SMALL FERROUS OBJECTS.

THE USE OF EXCESSIVE SOUND VOLUME THROUGH EARPHONES, HEADPHONES, OR HEADSETS MAY CAUSE HEARING LOSS.

DISCONNECT THE TELEPHONE LINE CORD FROM THIS PRODUCT IF THIS PRODUCT EMITS SMOKE, AN ABNORMAL SMELL OR MAKES UNUSUAL NOISE. THESE CONDITIONS CAN CAUSE FIRE OR ELECTRIC SHOCK. CONFIRM THAT SMOKE HAS STOPPED AND CONTACT AN AUTHORISED SERVICE CENTRE.

### **IMPORTANT NOTICE:**

- Under power failure conditions, the DPT may not operate. Please ensure that a separate telephone, not dependent on local power, is available for use in remote sites in case of emergency.
- This Class B digital apparatus complies with Canadian ICES-003.
- This product meets the applicable Industry Canada technical specifications.

## ***Important Information***

---

### **Important Safety Instructions**

When using this unit, basic safety precautions, including those below, should always be followed to reduce the risk of fire, electric shock and injury to persons.

1. Read and understand all instructions.
2. Follow all warnings and instructions marked on this unit.
3. Unplug this unit from the main unit before cleaning. Do not use liquid or aerosol cleaners. Clean with a soft cloth.
4. Do not use the unit near water, for example, near a bathtub, kitchen sink, or laundry tub, in a wet basement, or near a swimming pool.
5. Place this unit on a flat surface. Serious damage and/or injury may result if the unit falls.
6. The unit should never be placed near or over a radiator or other heat source.
7. Do not allow anything to rest on the extension cord. Do not locate this unit where the cord may be stepped on or tripped on.
8. To reduce the risk of fire or electric shock, do not overload wall outlets and extension cords.
9. Do not insert objects of any kind into this unit through openings, as they may touch dangerous voltage points or short out parts that could result in a risk of fire or electric shock. Never spill liquid of any kind on the unit.
10. To reduce the risk of electric shock, do not disassemble this unit. Only qualified personnel should service this unit. Opening or removing covers may expose you to dangerous voltages or other risks. Incorrect reassembly can cause electric shock.
11. Unplug this unit from the main unit and have the unit serviced by qualified service personnel in the following cases:
  - A. When the power supply cord or plug is damaged or frayed.
  - B. If liquid has been spilled on the unit.
  - C. If the unit has been exposed to rain or water.
  - D. If the unit does not operate according to this manual. Adjust only the controls that are explained in this manual. Improper adjustment of other controls may result in damage and may require service by a qualified technician to restore the product to normal operation.
  - E. If the unit has been dropped, or damaged.
  - F. If the unit's performance deteriorates.
12. Avoid using a wired telephone during an electrical storm. There is a remote risk of electric shock from lightning.
13. Do not use a telephone in the vicinity of a gas leak to report the leak.

**SAVE THESE INSTRUCTIONS**







## WALL MOUNTING TEMPLATE

1. Drive the screws into the wall as indicated.
2. Hook the unit onto the screw heads.

### Note:

Make sure to set the print size to correspond with the size of this page. If the dimensions of the paper output still deviate slightly from the measurements indicated here, use the measurements indicated here.

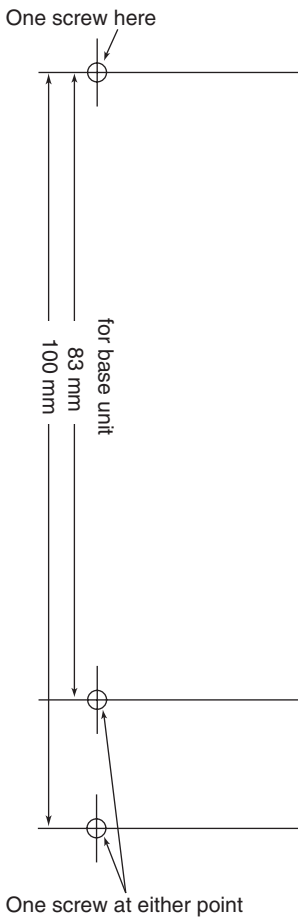

**Panasonic Canada Inc.**

5770 Ambler Drive, Mississauga, Ontario L4W 2T3

<http://www.panasonic.ca>

**Copyright:**

This material is copyrighted by Panasonic Communications Co., Ltd., and may be reproduced for internal use only. All other reproduction, in whole or in part, is prohibited without the written consent of Panasonic Communications Co., Ltd.

© Panasonic Communications Co., Ltd. 2009

**PSQX4697ZA** KK1208YH0 (C)